

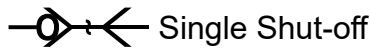

## MA TYPE (ONE-HAND QUICK COUPLING)

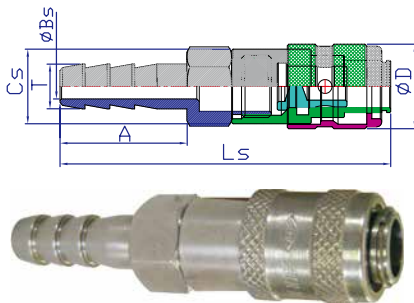

Major Applicable Fluid~  
 Stainless Steel: Frozen Lubricant/Acid/Brine  
 Brass: Oil/Fresh Water/Air  
 Steel: Circulating Lubricant/Fresh Water/Air

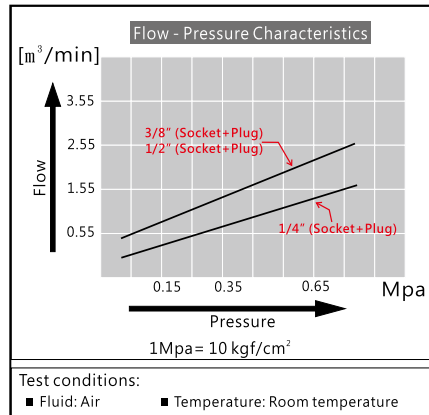

Computer No	Product Sign	Dimension (mm)						Weight (g)			Quantity per Carton
		Ls	D	Cs	A	T	Bs	SS41	BRASS	SUS	
SUS A2335MAJA BRASS A0115MAJA SS41 A1135MAJA	15SH	63.2	17	15	23	5.5	3	45	49	46	480-B
	20SH	65.7	17	15	25.5	7.2	4	40	43	40	480-B
	25SH	65.7	17	15	25.5	9	5	42	46	43	480-B
	30SH	65.7	17	15	25.5	11.3	7	44	48	45	480-B
	40SH	65.7	17	15	25.5	13.8	9.8	47	51	48	480-B

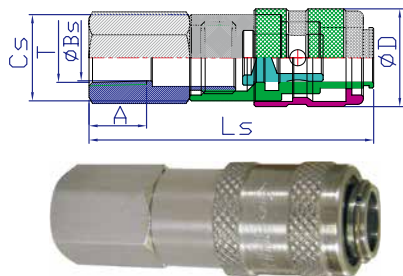

Computer No	Product Sign	Dimension (mm)						Weight (g)			Quantity per Carton
		Ls	D	Cs	A	T	Bs	SS41	BRASS	SUS	
SUS A2335MAJA BRASS A0115MAJA SS41 A1135MAJA	10SF	48.7	17	15	10	PT1/8"28P	9.9	41	45	42	480-B
	20SF	50.2	17	15	11.5	PT1/4"19P	13.4	51	55	51	480-B
	30SF	50.2	17	15	11.5	PT3/8"19P	16.9	63	68	63	480-B

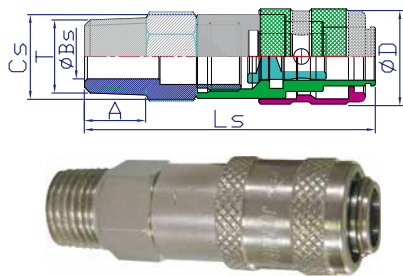

Computer No	Product Sign	Dimension (mm)						Weight (g)			Quantity per Carton
		Ls	D	Cs	A	T	Bs	SS41	BRASS	SUS	
SUS A2335MAJA BRASS A0115MAJA SS41 A1135MAJA	10SM	49.2	17	15	9	PT1/8"28P	5.5	39	42	39	480-B
	20SM	51.2	17	15	11	PT1/4"19P	8	41	44	41	480-B
	30SM	51.2	17	15	11	PT3/8"19P	11	47	51	48	480-B

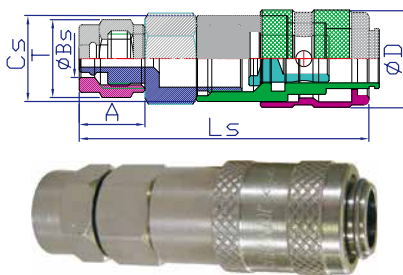

Computer No	Product Sign	Dimension (mm)						Weight (g)			Quantity per Carton
		Ls	D	Cs	A	T	Bs	SS41	BRASS	SUS	
SUS A2335MAJA BRASS A0115MAJA SS41 A1135MAJA	20SP	51.7	17	15	11.5	4*6	6.6	43	47	44	480-B
	25SP	53.2	17	15	13	5*8	8.2	48	52	49	480-B
	30SP	55.7	17	15	15.5	6.5*10	10.2	51	55	51	480-B

Max. pressure: 10Kg/cm<sup>2</sup>  
 Operating temp. range: A2335MAJA=VITON -20°C ~ +180°C  
 Uses: Pneumatic pressure hose, Pneumatic tools,  
 Air pressure machine, Automatic assembly machine.

Brass mark: A0115MAJA > -20°C ~ +80°C  
 Steel mark: A1135MAJA > -20°C ~ +80°C  
 Special seal(Packing) temperature range: -50°C ~ +300°C

Dimension of T: NPT, BSP, etc. are available to produce besides PT. (Welcome to order special threads)

## MA TYPE (ONE-HAND QUICK COUPLING)

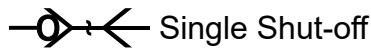

Major Applicable Fluid~

Stainless Steel: Frozen Lubricant/Acid/Brine

Brass: Oil/Fresh Water/Air

Steel: Circulating Lubricant/Fresh Water/Air

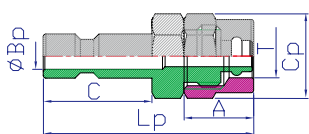
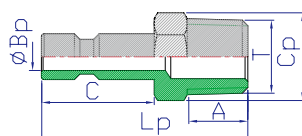
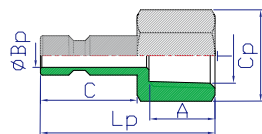
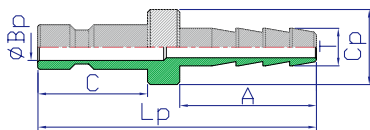
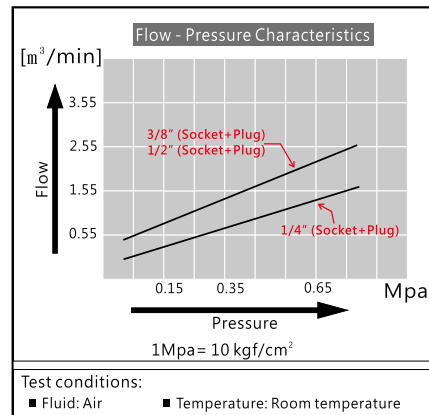

Computer No	Product Sign	Dimension (mm)						Weight (g)			Quantity per Carton
		Lp	C	Cp	A	T	Bp	SS41	BRASS	SUS	
SUS A2335MAJA BRASS A0115MAJA SS41 A1135MAJA	15PH	49.5	20.5	14	23	5.5	5	14	15	14	480-B
	20PH	52	20.5	14	25.5	7.2	5	15	16	15	480-B
	25PH	52	20.5	14	25.5	9	5	18	20	19	480-B
	30PH	52	20.5	14	25.5	11.3	5	19	21	20	480-B
40PH	52	20.5	14	25.5	13.8	5	22	24	22	480-B	

Computer No	Product Sign	Dimension (mm)						Weight (g)			Quantity per Carton
		Lp	C	Cp	A	T	Bp	SS41	BRASS	SUS	
SUS A2335MAJA BRASS A0115MAJA SS41 A1135MAJA	10PF	35	20.5	Ø16*6HEX*14D	12	PT1/8"28P	5	18	19	18	480-B
	20PF	37	20.5	Ø19.5*6HEX*17D	14	PT1/4"19P	5	24	26	24	480-B
	30PF	37	20.5	Ø24*6HEX*21D	14	PT3/8"19P	5	32	35	33	480-B

Computer No	Product Sign	Dimension (mm)						Weight (g)			Quantity per Carton
		Lp	C	Cp	A	T	Bp	SS41	BRASS	SUS	
SUS A2335MAJA BRASS A0115MAJA SS41 A1135MAJA	10PM	36.5	20.5	Ø12.6*6HEX*11D	10	PT1/8"28P	5	12	13	12	480-B
	20PM	37.5	20.5	Ø16*6HEX*14D	11	PT1/4"19P	5	16	17	16	480-B
	30PM	37.5	20.5	Ø19.5*6HEX*17D	11	PT3/8"19P	5	21	23	21	480-B

Computer No	Product Sign	Dimension (mm)						Weight (g)			Quantity per Carton
		Lp	C	Cp	A	T	Bp	SS41	BRASS	SUS	
SUS A2335MAJA BRASS A0115MAJA SS41 A1135MAJA	20PP	38	20.5	Ø16*6HEX*14D	11.5	4*6	5	19	21	20	480-B
	25PP	39.5	20.5	Ø16*6HEX*14D	13	5*8	5	21	23	21	480-B
	30PP	41.5	20.5	Ø16*6HEX*14D	15.5	6.5*10	5	29	32	30	480-B

### Coupling Releasing

S & P



### Coupling Fitting

S + P



- Max. pressure: 10Kg/cm<sup>2</sup>
- Operating temp. range: A2335MAJA=VITON -20°C ~ +180°C
- Uses: Pneumatic pressure hose, Pneumatic tools, Air pressure machine, Automatic assembly machine.
- Brass mark: A0115MAJA > -20°C ~ +80°C
- Steel mark: A1135MAJA > -20°C ~ +80°C
- Special seal(Packing) temperature range: -50°C ~ +300°C

Dimension of T: NPT, BSP, etc. are available to produce besides PT. (Welcome to order special threads)